

**SIMPSON****Strong-Tie**

# Plan de fixation



REV

0

REV DATE

20/08/24

DWG NAME

C\_ACW155\_2D0\_NP\_CTR-6-FR

Référence

=

ACW155

Fixations

=

Bois sur support rigide

Poteau sur support rigide

Type de fixation

=

Clouage partiel

Plan de fixation N° 6

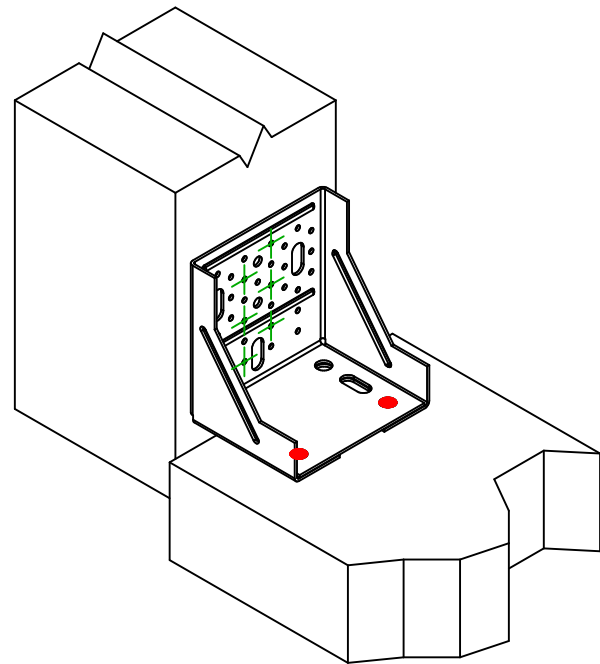
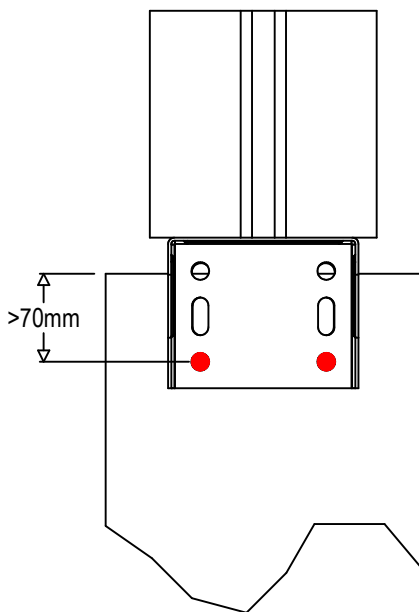
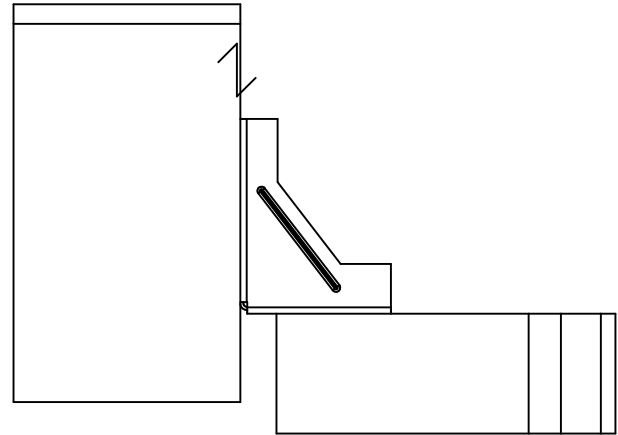
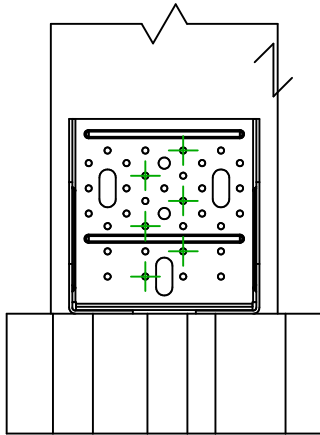
Fixation(s)  
Porteur

Symbole



Fixations

FM753  

Références

FM 753 EVO M12X104/5

Qté

LMAS  

LMASM12-150/35

2

THD  

THD10X80/5

Fixation(s)  
Porté

Symbole

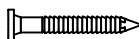

Fixations

CNA  

Références

CNA4.0X35

Qté

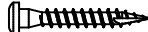
CSA  

CSA5.0X35

6