

SIMPSON**Strong-Tie**

Bevestigingspatroon



REV

0

REV DATE

19/08/24

DWG NAME

C_ABR220_2D0_NP_CTR-4-NL

Art. Nr.

=

ABR220

Bevestigingsmiddelen

=

hout op harde ondergrond

Kolom tot harde steun

Type bevestiging

=

Gedeeltelijke vernageling

Bevestigingsplan n° 4

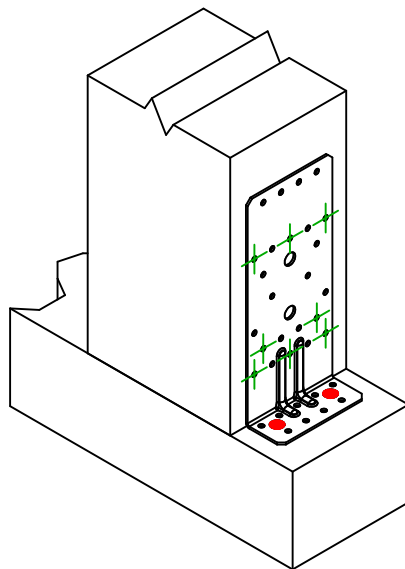
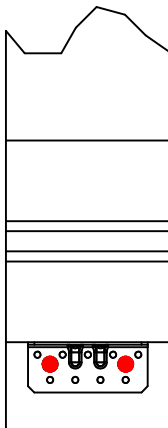
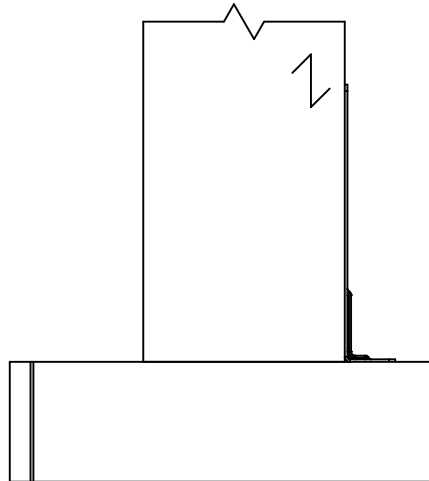
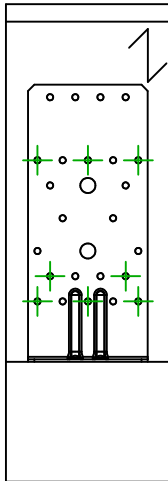

Uitvoering 1 hoekijzer

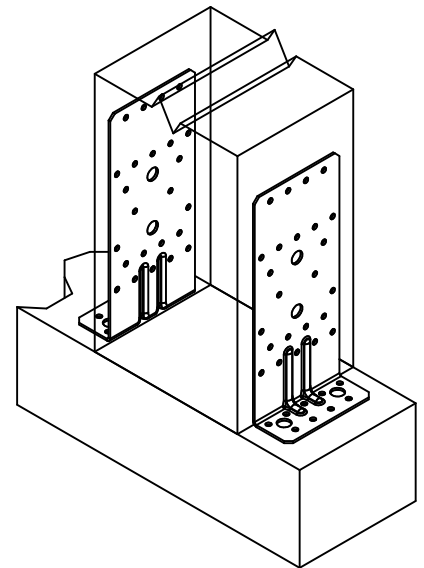
Uitvoering 2
hoekijzers

	Symbol	Bevestigingsmiddelen	Art. Nr.	Aantal
Draagbalk Bevestigingen		FM753	FM 753 EVO M10X78/5	2
		LMAS	LMASM10-120/25	
		THD	THD8X70/5	
Balk bevestiging(en)		CNA	CNA4.0X40/50/60	8
		CSA	CSA5.0X40/50	